



Product Information

SCL-RHYTHM

M.2 NVMe Mass Storage & Quad M12 Gigabit Ethernet Networking

Mezzanine I/O Expansion Board (CPU Side Card)

Document No. 8856 • 26 February 2021



General

The SCL-RHYTHM is a mezzanine side card for EKF CPU boards, provided with a socket for a PCI Express® based M.2 mass storage module, and four independent Gigabit Ethernet controllers for universal networking.

The SCL-RHYTHM is suitable for EKF CPU cards such as the SC5-FESTIVAL or SC9-TOCCATA, which are equipped with two HSE (high speed expansion) mezzanine connectors, for eight PCIe® Gen3 lanes.

The M.2 socket can accommodate an NVMe type SSD module up to the 2280 form factor, with a PCIe® x4 Gen3 interface for superior data transfer rates. When used as main mass storage device, the NVMe SSD can speed up the overall system performance dramatically.

Four I210-IT networking controllers supporting TSN Gigabit Ethernet are wired to X-coded M12 front panel connectors, for rugged applications such as railway and transportation.

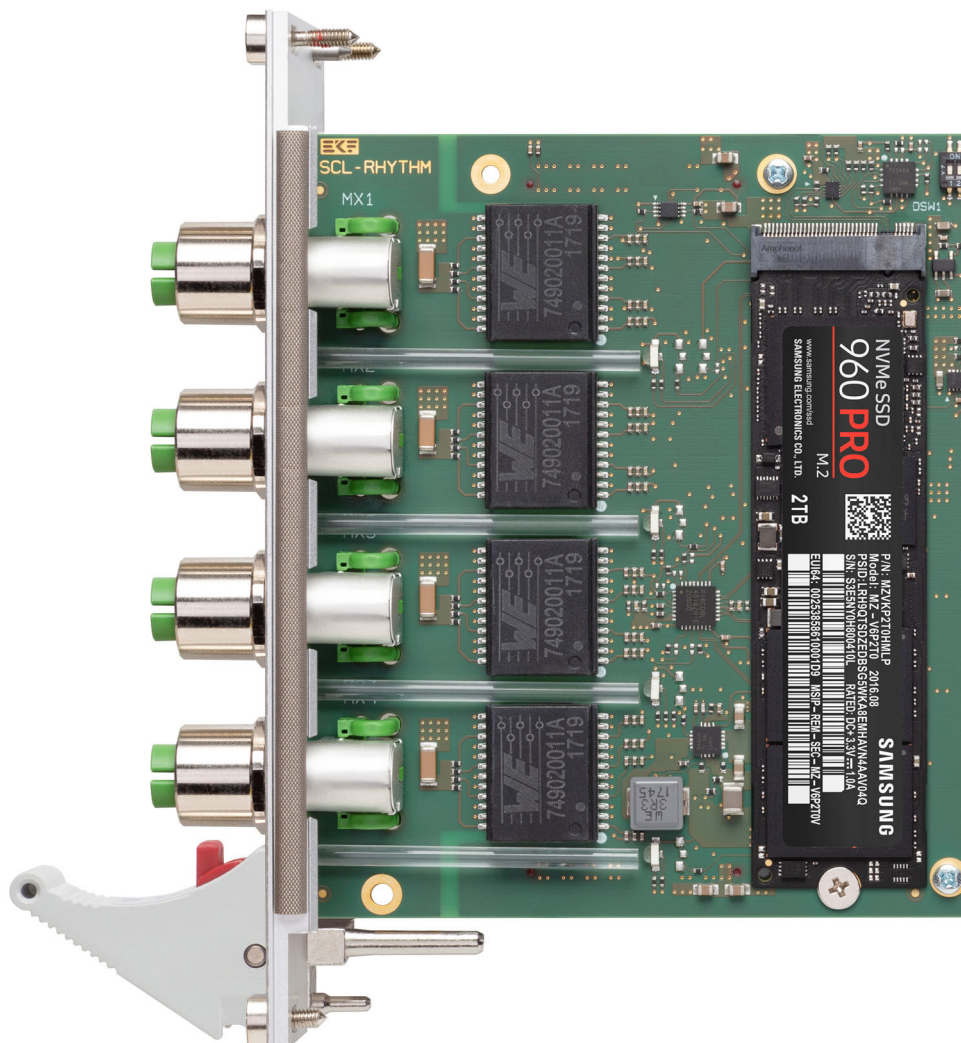

Features

Feature Summary

General

- ▶ Mixed function mezzanine side card for EKF CompactPCI® Serial CPU boards
- ▶ Based on new mezzanine connectors HSE1/HSE2 (8 x PCIe® Gen3)
- ▶ Suitable e.g. for use with CPU cards SC4-CONCERTO, SC5-FESTIVAL, SC9-TOCCATA
- ▶ Provides Gigabit Ethernet front panel I/O (4 x M12-X)
- ▶ Provides mass storage capability (M.2 NVMe)
- ▶ 8HP assembly together with CPU card
- ▶ Proprietary PCB dimensions for optimized CPU card processor heat sink

Front Panel I/O

- ▶ 4 x M12 X-coded front panel GbE receptacles, rail approved, Cat6A, IEC 61076-2-109
- ▶ 1000BASE-T, 100BASE-TX, 10BASE-T compliant data transfer rate front ports
- ▶ Future proof investment into cabling infrastructure - up to 10Gbps with M12 Cat6A
- ▶ M12 X-coded to RJ45 connector Cat6A cable assemblies available from several suppliers

Networking

- ▶ Four individual networking interface controllers (NIC), based on PCI Express®
- ▶ 1000BASE-T, 100BASE-TX, 10BASE-T connections
- ▶ Intel® I210-IT -40°C to +85°C operating temperature GbE controllers w. integrated PHY
- ▶ IPv4/IPv6 checksum offload, 9.5KB Jumbo Frame support, EEE Energy Efficient Ethernet
- ▶ IEEE 802.1Qav Audio-Video-Bridging (AVB) enhancements for time-sensitive streams (TSN)
- ▶ IEEE 1588 and 802.1AS packets time stamping for high-precision time synchronization
- ▶ All GbE ports wired via M12 X-coded front panel connectors

On-Board Mass Storage

- ▶ M.2 (formerly known as NGFF) socket for an NVMe type SSD module up to 2280 size
- ▶ PCI Express® Gen3 x4 interface (M-key socket)
- ▶ Socket height 4.2H (double sided module allowed)
- ▶ Capacity up to 2TB as of current
- ▶ Suitable for operating system installation (boot device)

Feature Summary

Applications

- ▶ Local expansion (side card) for EKF CPU boards
- ▶ Industrial networks - IoT - TSN
- ▶ Rugged environments
- ▶ Router and gateway
- ▶ Data acquisition
- ▶ Edge computing
- ▶ Railway usage via front panel M12 cabling
- ▶ Transportation vehicles, construction and harvesting machinery

Environmental, Regulatory

- ▶ Designed & manufactured in Germany
- ▶ ISO 9001 certified quality management
- ▶ Custom specific development available on request
- ▶ Long term availability
- ▶ Rugged solution
- ▶ Coating, sealing, underfilling on request
- ▶ RoHS compliant
- ▶ Operating temperature -40°C to +85°C (industrial temperature range)
- ▶ Storage temperature -40°C to +85°C, max. gradient 5°C/min
- ▶ Humidity 5% ... 95% RH non condensing
- ▶ Altitude -300m ... +3000m
- ▶ Shock 15g 0.33ms, 6g 6ms
- ▶ Vibration 1g 5-2000Hz
- ▶ EC Regulations EN55022, EN55024, EN60950-1 (UL60950-1/IEC60950-1)
- ▶ MTBF 48.9 years

System Requirements

The SCL-RHYTHM is a mezzanine side card, to be fixed on top of a suitable CPU carrier board. The pitch between carrier PCB and mezzanine PCB is 4HP, resulting in a 8HP common front panel for the entire assembly. Two mezzanine inter-board connectors are provided, for distribution of PCI Express® signals from the CPU carrier to the SCL-RHYTHM side board.

The SCL-RHYTHM also is a carrier board itself, which accommodates an M.2 NVMe SSD storage module.

It is recommended to use a CompactPCI® Serial backplane which provides the CPU card system slot on the right edge, in order to prevent loss of a peripheral slot (the SCL-RHYTHM is then positioned out of the backplane shape).

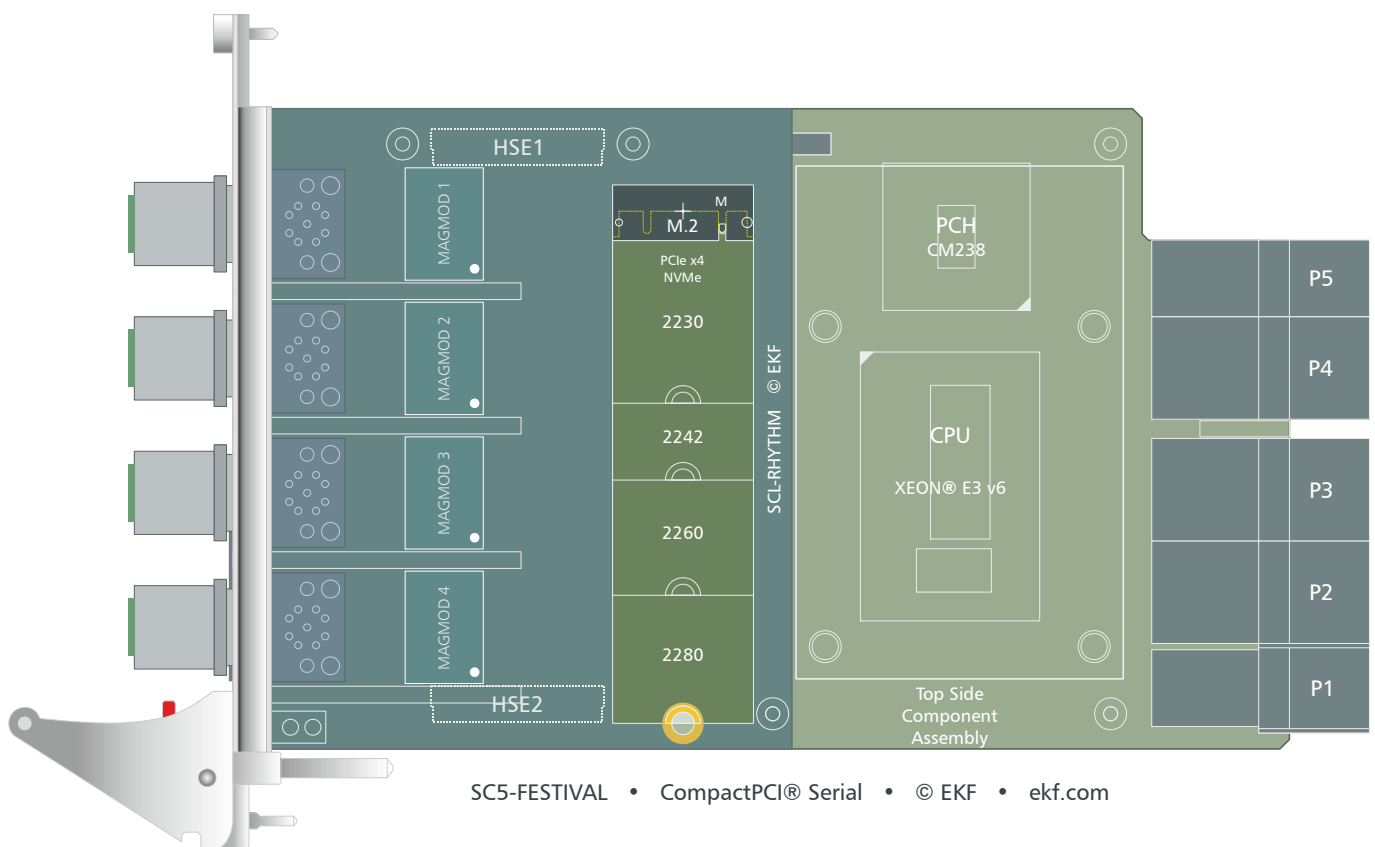

The SCL-RHYTHM can be used e.g. with the SC5-FESTIVAL CPU card. The SCL PCB does not cover the CPU board with respect to the heat sink area.

Hence, the CPU card may be equipped with a heat sink which utilises the full 8HP height available for the assembly unit, for optimized heat dissipation.

Front Panel

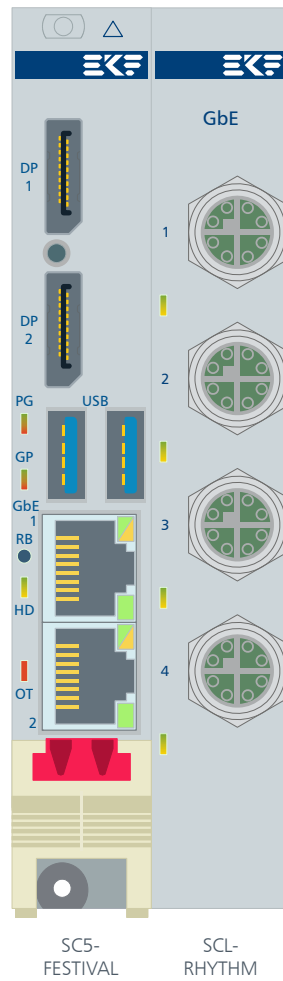

8HP Assembly Shown

Block Diagram

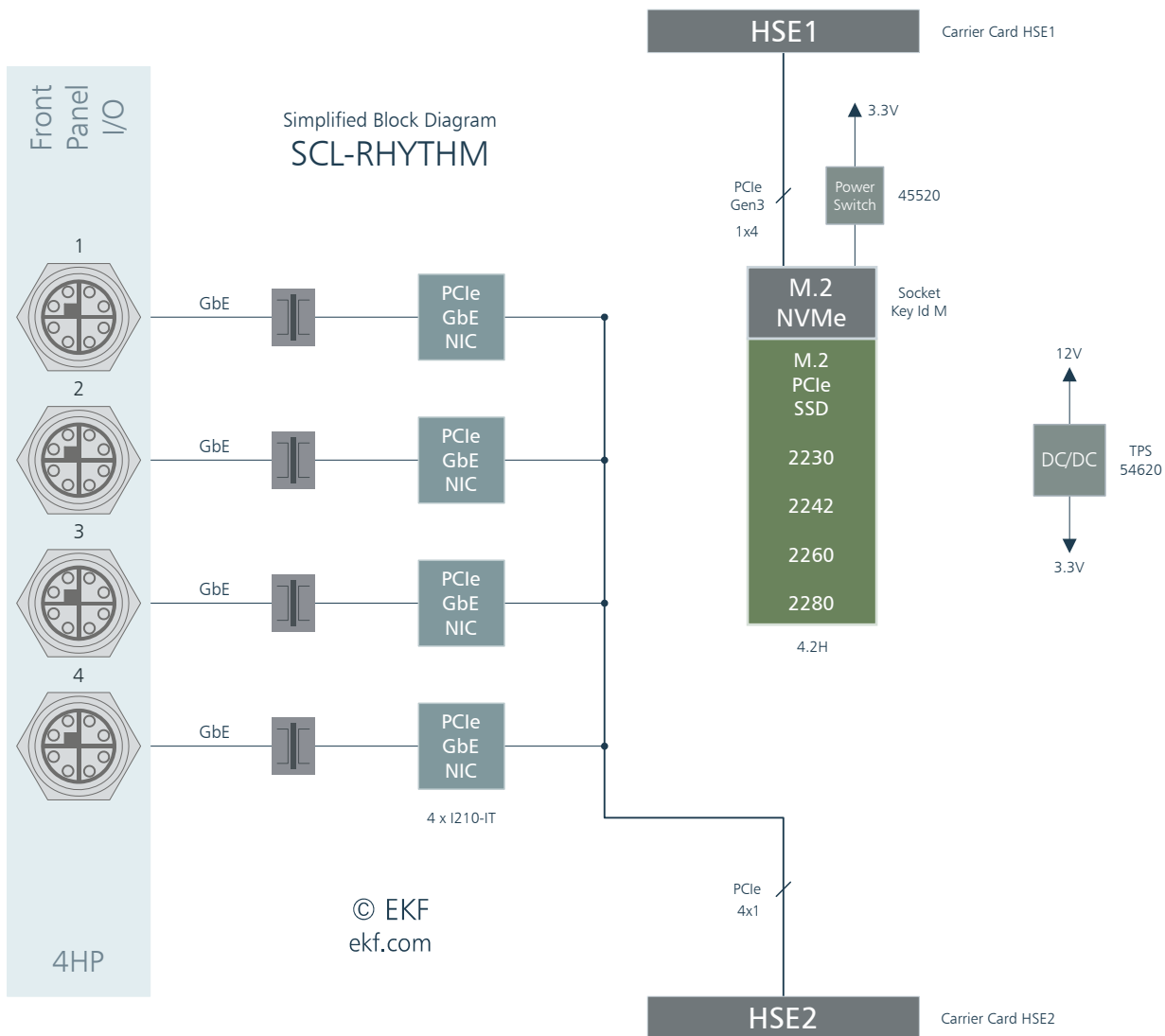

M.2 Connector

The SCL-RHYTHM is provided with an M.2 NVMe module host connector (M-key). After inserted, the M.2 module must be locked manually by a screw, in order to withstand shock and vibration.

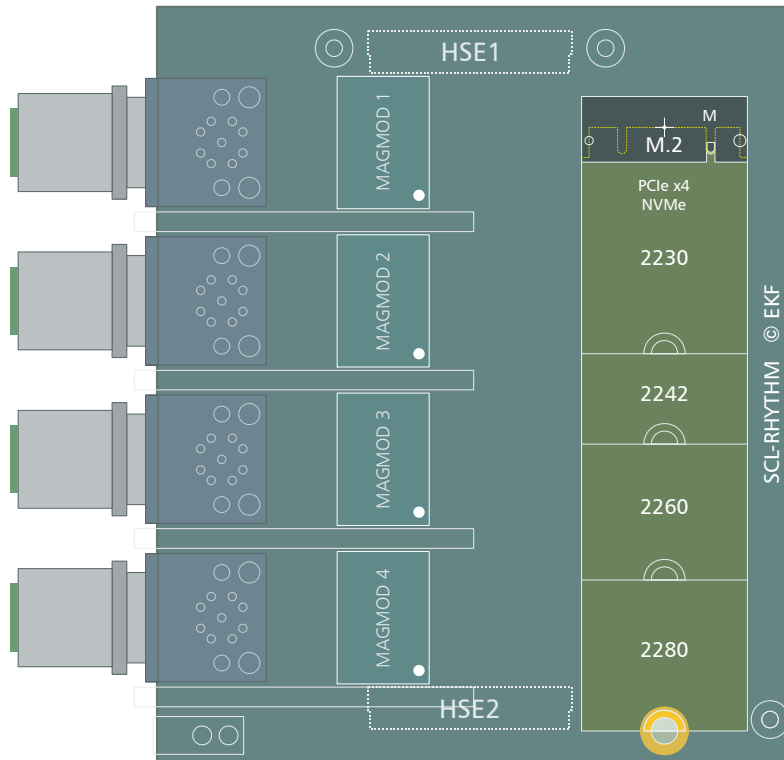

M.2 Module Fixation (Picture Similar)

NVMe PCIe x4 M.2 M-Key • Pin 1 - 38 EKF Part #255.50.2.2223.10			
GND	1	2	+3.3V
GND	3	4	+3.3V
PETN3	5	6	NC
PETP3	7	8	NC
GND	9	10	LED1#
PERN3	11	12	+3.3V
PERP3	13	14	+3.3V
GND	15	16	+3.3V
PETN2	17	18	+3.3V
PETP2	19	20	NC
GND	21	22	NC
PERN2	23	24	NC
PERP2	25	26	NC
GND	27	28	NC
PETN1	29	30	NC
PETP1	31	32	NC
GND	33	34	NC
PERN1	35	36	NC
PERP1	37	38	NC



NVMe PCIe x4			
M.2 M-Key continued • Pin 39 - 75			
GND	39	40	SMB_CLK *
PETNO	41	42	SMB_DATA *
PETPO	43	44	ALERT *
GND	45	46	NC
PERNO	47	48	NC
PERPO	49	50	PERST#
GND	51	52	CLKREQ#
REFCLKN	53	54	PEWAKE#
REFCLKP	55	56	RSV
GND	57	58	RSV
M-Key	59	60	M-Key
M-Key	61	62	M-Key
M-Key	63	64	M-Key
M-Key	65	66	M-Key
NC	67	68	SUSCLK
PEDET	69	70	+3.3V
GND	71	72	+3.3V
GND	73	74	+3.3V
GND	75		

* Logic level 1.8V signals - LSF0204 level shifter to 3.3V on-board

PCI Express® M.2 Specification Socket 3 PCIe-based Module Pinout (Module Key M)

M12 X-Coded Front Panel Receptacles

M12 X-Coded Front Panel I/O Receptacles 1 - 4
 Gigabit Ethernet • 271.12.008.20 • M12-X Flush-type socket 1+10 Gigabit Ethernet

271.12.008.00

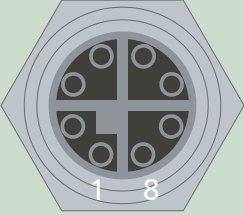

F/P LEDs
 yellow=1Gbit/s green=100Mbit/s off=10Mbit/s
 on=link established blinking=activity (data)

© EKF • ekf.com
 Draft - Do Not Scale

Ports 1-4	1	MDX0+
	2	MDX0-
	3	MDX1+
	4	MDX1-
	5	MDX3+
	6	MDX3-
	7	MDX2-
	8	MDX2+

The pin numbers of an M12 X-coded connector do not reflect the RJ45 Gigabit Ethernet signal assignment. For cross-over patch cables M12 to RJ45 please refer to the table below.

M12 X	Signal Colors T568B	RJ45
1	MDX0+ white/orange	1
2	MDX0- orange	2
3	MDX1+ white/green	3
4	MDX1- green	6
5	MDX3+ white/brown	7
6	MDX3- brown	8
7	MDX2- white/blue	5
8	MDX2+ blue	4

Suitable industrial Gigabit Ethernet M12 cable assemblies can be ordered from EKF, or directly from well-known cable and connector manufacturers e.g. Metz, Phoenix, Escha and many others.



M12 to M12 Cable
Phoenix Contact



M12 Cable Connector
Phoenix Contact

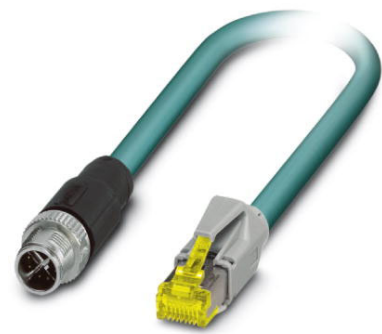

M12 to RJ45 Cable
Phoenix Contact



M12 Gigabit Ethernet Cable Assembly

Ordering Information Cable Assemblies

Gigabit Ethernet cable M12 to M12: #271.14.008.xx (xx=length/meter)
Gigabit Ethernet cable M12 to RJ-45: #271.15.008.xx (xx=length/meter)

Mezzanine Connectors HSE1, HSE2

The SCL-RHYTHM is provided with two male mezzanine connectors on the bottom side of the PCB, which mate with the female mezzanine connectors on the carrier CPU card, for a resulting board-to-board mounting height of 18.7mm (4HP effective pitch, 8HP F/P width in total).

HSE1

HSE1 is used to pass a PCIe[®] x4 link from the CPU carrier card to the on-board M.2 NVMe connector, for a suitable SSD mass storage module.

HSE2

HSE2 is provided to supply the SCL-RHYTHM side card with additional PCIe[®] lanes. A PCIe[®] x1 link is established for each of the on-board I210-IT Gigabit Ethernet controllers. This requires the CPU carrier card HSE2 connector configured to PCIe[®] 4x1 (and not PCIe[®] 1x4 or 2x2).

Carrier card connector 8mm female ERNI Microspeed 275.90.08.068.01
 Supplement 10mm male connector for nominal height 18mm (SC* side card, B2B 18.7mm)

High Speed Expansion P-HSE1				
<p>© EKF 275.90.01.068.51 ekf.com</p> <p>1.00mm Pitch High Speed Male Connector</p>	CFG_34 *	b1	a1	CFG_12 *
	3_PCIE_TXP	b2	a2	1_PCIE_TXP
	3_PCIE_TXN	b3	a3	1_PCIE_TXN
	GND	b4	a4	GND
	3_PCIE_RXN	b5	a5	1_PCIE_RXN
	3_PCIE_RXP	b6	a6	1_PCIE_RXP
	GND	b7	a7	GND
	4_PCIE_TXP	b8	a8	2_PCIE_TXP
	4_PCIE_TXN	b9	a9	2_PCIE_TXN
	GND	b10	a10	GND
	4_PCIE_RXN	b11	a11	2_PCIE_RXN
	4_PCIE_RXP	b12	a12	2_PCIE_RXP
	GND	b13	a13	GND
	2_USB3_TXP	b14	a14	1_USB2_P
	2_USB3_TXN	b15	a15	1_USB2_N
	GND	b16	a16	GND
	2_USB3_RXP	b17	a17	2_USB2_P
	2_USB3_RXN	b18	a18	2_USB2_N
	GND	b19	a19	GND
	PCIE_CLK_P	b20	a20	1_2_USB_OC#
	PCIE_CLK_N	b21	a21	PLTRST#
	+5VS ¹⁾	b22	a22	+3.3VS ¹⁾
	+5VS ¹⁾	b23	a23	+3.3VS ¹⁾
	+5VPS ²⁾	b24	a24	+3.3VA ³⁾
	+12VPS ²⁾	b25	a25	+12VPS ²⁾

* CFG_12 and CFG_34 = open (10k PU on CPU carrier board) indicating that a PCIe x4 link is requested

- 1) Power rail switched on in S0 state only
- 2) Power rail switched on in S0-S4 state
- 3) Power always on

Carrier card connector 8mm female ERNI Microspeed 275.90.08.068.01
 Supplement 10mm male connector for nominal height 18mm (SC* side card, B2B 18.7mm)

High Speed Expansion P-HSE2				
	3_PCIE_TXP	b1	a1	1_PCIE_TXP
	3_PCIE_TXN	b2	a2	1_PCIE_TXN
	GND	b3	a3	GND
	3_PCIE_RXN	b4	a4	1_PCIE_RXN
	3_PCIE_RXP	b5	a5	1_PCIE_RXP
	GND	b6	a6	GND
	4_PCIE_TXP	b7	a7	<i>2_PCIE_TXP</i>
	4_PCIE_TXN	b8	a8	<i>2_PCIE_TXN</i>
	GND	b9	a9	GND
	4_PCIE_RXN	b10	a10	2_PCIE_RXN
	4_PCIE_RXP	b11	a11	2_PCIE_RXP
	GND	b12	a12	GND
	<i>DP_LANE2_P</i>	b13	a13	<i>DP_LANE0_P</i>
	<i>DP_LANE2_N</i>	b14	a14	<i>DP_LANE0_N</i>
	GND	b15	a15	GND
	<i>DP_LANE3_P</i>	b16	a16	<i>DP_LANE1_P</i>
	<i>DP_LANE3_N</i>	b17	a17	<i>DP_LANE1_N</i>
	GND	b18	a18	GND
	<i>DP_AUX_P</i>	b19	a19	PCIE_CLK_P
	<i>DP_AUX_N</i>	b20	a20	PCIE_CLK_N
	<i>DP_CFG1</i>	b21	a21	GND
	<i>DP_HPD</i>	b22	a22	SMB_SCL ¹⁾
	PLTRST#	b23	a23	SMB_SDA ¹⁾
	+12VPS ²⁾	b24	a24	+12VPS ²⁾
	+12VPS ²⁾	b25	a25	+12VPS ²⁾

italic/grey pins are NC (shown for reference only)

PCIe® can pre-configured 1x4, 2x2, 4x1 via soft-straps (Flash image CPU carrier card). For the SCL-RHYTHM PCIe® 4x1 is mandatory. If misaligned, only one or two NICs will be present after system enumeration.

1) Connection to SMBus, isolated after system reset 2) Power rail switched on in S0-S4 state

Ordering Information

For popular SCL-RHYTHM SKUs please refer to www.ekf.com/liste/liste_21.html#SCL

Please note that the SCL-RHYTHM is a carrier card which typically comes without M.2 module populated, unless otherwise expressly ordered. Photos shown within this document and at other places may be equipped with M.2 modules just for application demonstration. If you need a turnkey solution with an M.2 NVMe storage module populated, please contact sales@ekf.com before ordering.

Related Documents CompactPCI® Serial

Basics / Overview CompactPCI® Serial	www.ekf.com/s/smart_solution.pdf
CompactPCI® Serial Home	www.ekf.com/s/serial.html

Recommended CPU Cards

SC4-CONCERTO	www.ekf.com/s/sc4/sc4.html
SC5-FESTIVAL	www.ekf.com/s/sc5/sc5.html
<i>SC9-TOCCATA</i>	www.ekf.com/s/sc9/sc9.html



Due to the special dimensions of the SCL-RHYTHM PCB, the heatsink of the CPU carrier card remains uncovered, which would allow mounting of a custom specific height cooler, for improved heat dissipation.



Assembly w. Custom Specific Height CPU Heatsink

Beyond All Limits: EKF High Performance Embedded

Industrial Computers Made in Germany
boards. systems. solutions.

EKF Elektronik GmbH
Philipp-Reis-Str. 4 (Haus 1)
Lilienthalstr. 2 (Haus 2)
59065 HAMM
Germany



Phone +49 (0)2381/6890-0
Fax +49 (0)2381/6890-90
Internet www.ekf.com
E-Mail sales@ekf.com